



Citi's 2018 Small & Mid Cap Conference

*New York, NY
June 6, 2018*



Forward-Looking Statements



This communication includes forward-looking statements within the meaning of the Private Securities Litigation Reform Act of 1995. These statements relate to analyses and other information that are based on management's beliefs, certain assumptions made by management, forecasts of future results, and current expectations, estimates and projections about the markets and economy in which we and our various segments operate. The statements contained in this presentation that are not statements of historical fact may include forward-looking statements that involve a number of risks and uncertainties.

We have used the words "anticipate," "intend," "may," "expect," "believe," "should," "plan," "project," "estimate," "forecast," "optimistic," and variations of such words and similar expressions in this presentation to identify such forward-looking statements. These statements are not guarantees of future performance and involve certain risks, uncertainties and assumptions, which are difficult to predict and many of which are beyond our control. Therefore, actual outcomes and results may differ materially from those matters expressed or implied in such forward-looking statements. All references to expectations and other forward-looking statements are based on expectations at May 1, 2018. Olin undertakes no obligation to update publicly any forward-looking statements, whether as a result of future events, new information or otherwise.

Factors that could cause or contribute to such differences include, but are not limited to: our sensitivity to economic, business and market conditions in the U.S. and overseas; the cyclical nature of our operating results and the supply/demand balance for our products; our reliance on a limited number of suppliers for specified feedstock and services, including third-party transportation services; higher-than-expected raw material and energy, transportation, and/or logistics costs; failure to control costs or to achieve targeted cost reductions; new regulations or public policy changes regarding the transportation of hazardous chemicals and the security of chemical manufacturing facilities; the occurrence of unexpected manufacturing interruptions and outages; complications resulting from our multiple enterprise resource planning systems and the conversion to one system; changes in, or failure to comply with, legislation or government regulations or policies; the failure or an interruption of our information technology systems; economic and industry downturns; declines in global equity markets and interest rates impacting pension plan asset values and liabilities; fluctuations in foreign currency exchange rates; unexpected litigation outcomes and environmental investigation and remediation costs; our substantial amount of indebtedness and debt service obligations; the integration of the Dow Chemical Products Business not fully realizing the benefits of the anticipated synergies; the failure to attract, retain and motivate key employees; asset impairment charges resulting from the failure to realize our long range plan assumptions; adverse conditions in the credit and capital markets; and the other risks detailed in Olin's Form 10-K for the fiscal year ended December 31, 2017. All of the forward-looking statements should be considered in light of these factors. In addition, other risks and uncertainties not presently known to Olin or that Olin considers immaterial could affect the accuracy of our forward-looking statements. The reader is cautioned not to rely unduly on these forward-looking statements.

Non-GAAP Financial Measures

In addition to U.S. GAAP financial measures, this presentation includes certain non-GAAP financial measures including EBITDA, and Adjusted EBITDA. These non-GAAP measures are in addition to, not a substitute for or superior to, measures for financial performance prepared in accordance with U.S. GAAP. Definitions of these measures and reconciliation of GAAP to non-GAAP measures are provided in the appendix to this presentation.

Company Overview



Olin Corporation		
	1Q 2018	FY 2017 ¹
Revenue:	\$ 1,710	\$ 6,268
Adjusted EBITDA: ²	\$ 240	\$ 944

Chlor Alkali Products and Vinyls			
	1Q18	FY '17	
Revenue:	\$ 936	\$ 3,501	
Adj. EBITDA:	\$ 244	\$ 838	

Epoxy			
	1Q18	FY '17	
Revenue:	\$ 603	\$ 2,086	
Adj. EBITDA:	\$ 5	\$ 83	

Winchester			
	1Q18	FY '17	
Revenue:	\$ 171	\$ 681	
Adj. EBITDA:	\$ 17	\$ 92	

All financial data are for the three months ended March 31, 2018 and the twelve months ended December 31, 2017. Data are presented in millions of U.S. dollars. Additional information is available at www.olin.com.

¹: Chlor Alkali Products and Vinyls full year 2017 Adjusted EBITDA was reduced by \$27 million and Epoxy full year 2017 Adjusted EBITDA was reduced \$27.7 million as a result of incremental costs to continue operations and unabsorbed fixed manufacturing costs and reduced profit from lost sales associated with Hurricane Harvey.

²: Olin's definition of "Adjusted EBITDA" (earnings before interest, taxes, depreciation and amortization) is net income (loss) plus an add-back for depreciation and amortization, interest expense (income), income tax expense (benefit), other expense (income), restructuring charges, acquisition-related costs and certain non-recurring items.

Key Takeaways from First Quarter 2018



1. Most significant planned maintenance turnarounds are behind us

2. Pricing has moved higher for Chlor Alkali Products & Vinyls and Epoxy businesses

3. Winchester 2018 outlook is weaker

4. Share repurchase program authorized

Olin is a Global Leader in Chlorine Derivatives



Global:

- **Top quartile chlor-alkali cost position**
- #1 chlor-alkali producer
- #1 seller of membrane grade caustic soda
- #1 supplier of epoxy materials
- #1 seller of chlorinated organic
- Broadest geographic presence in caustic, epoxy and chlorinated organics

North America:

- **Most diversified chlorine envelope of any North America producer**
- #1 seller of chlorine
- #1 seller of industrial bleach
- #1 seller of on-purpose hydrochloric acid
- Full ownership of newest, world-scale membrane chlor-alkali facility
- The most extensive distribution and logistics network

Significantly Expanded Chlorine End Uses

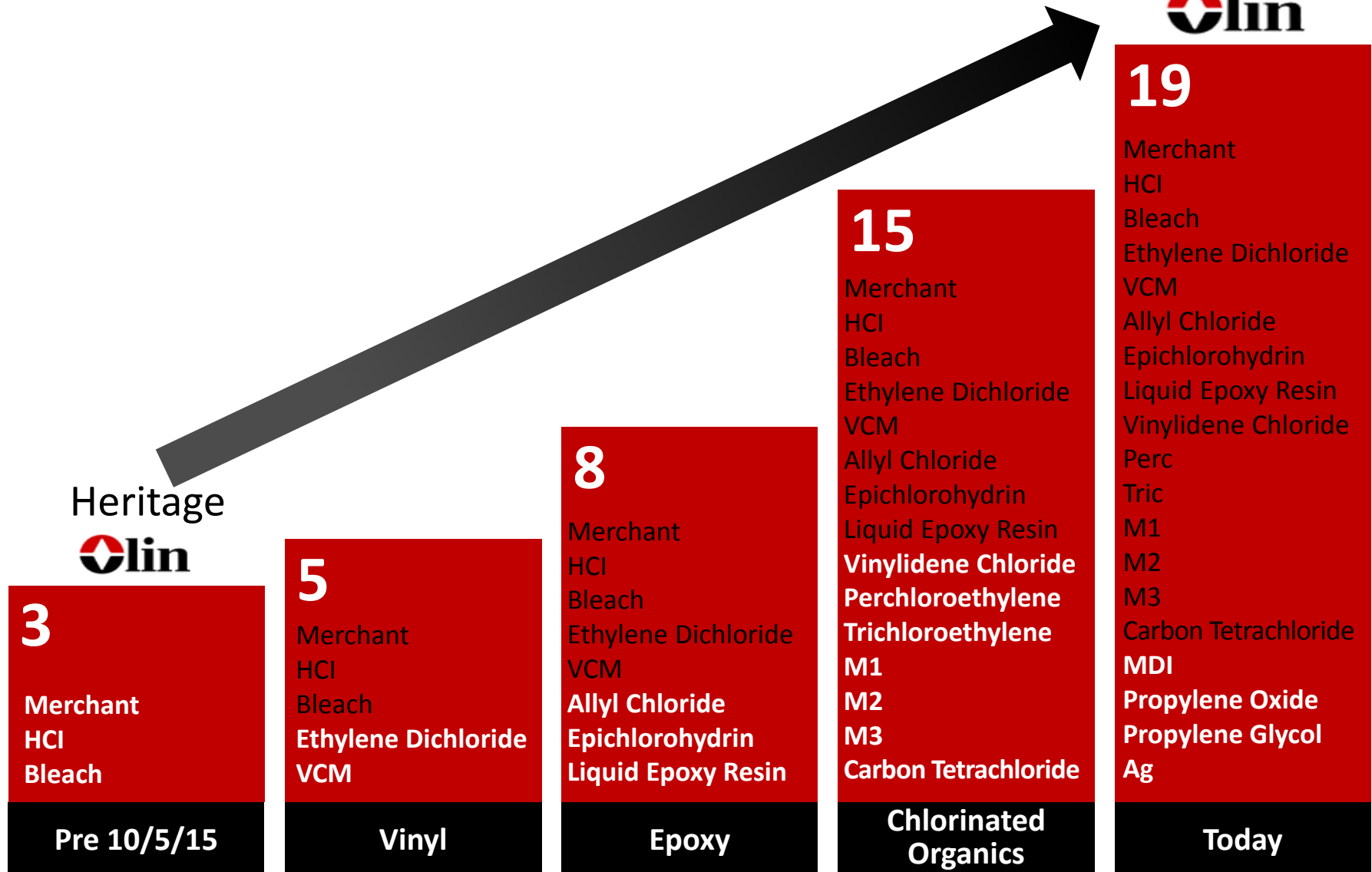

Favorable Chlor-Alkali Industry Dynamics Continue



- North American capacity reduction in 1Q18, no material chlor alkali plants coming on line in the next 2 to 3 years
- 2017 global operating rates 83%; 2017 U.S. operating rates 86%
- Favorable caustic soda dynamics continue:
 - 2015-2017 U.S. exports increased 38% to 3.6 million tons, imports down 25% to 550,000 tons
 - 2015-2017 U.S. exports to Brazil increased 30% to 1.3 million tons
 - 2017 Chinese exports down 12% from 2015 levels to 850,000 tons

Caustic Soda and Chlorine Prices
January 2015 to April 2018

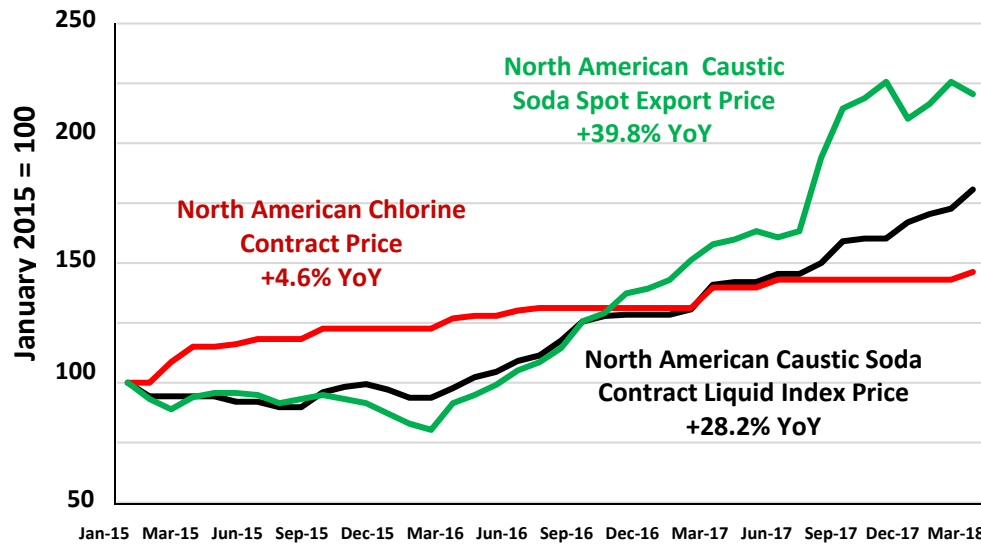

Source: IHS Markit and Tecnon

U.S. Caustic Soda Imports and Exports
(in millions of short tons)

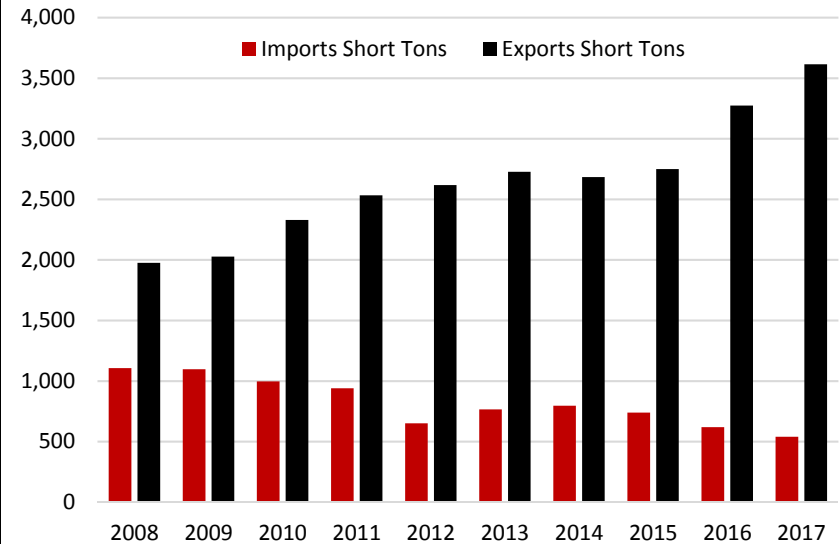

EDC Pricing History 2000 – April 2018



EDC Spot Export Prices

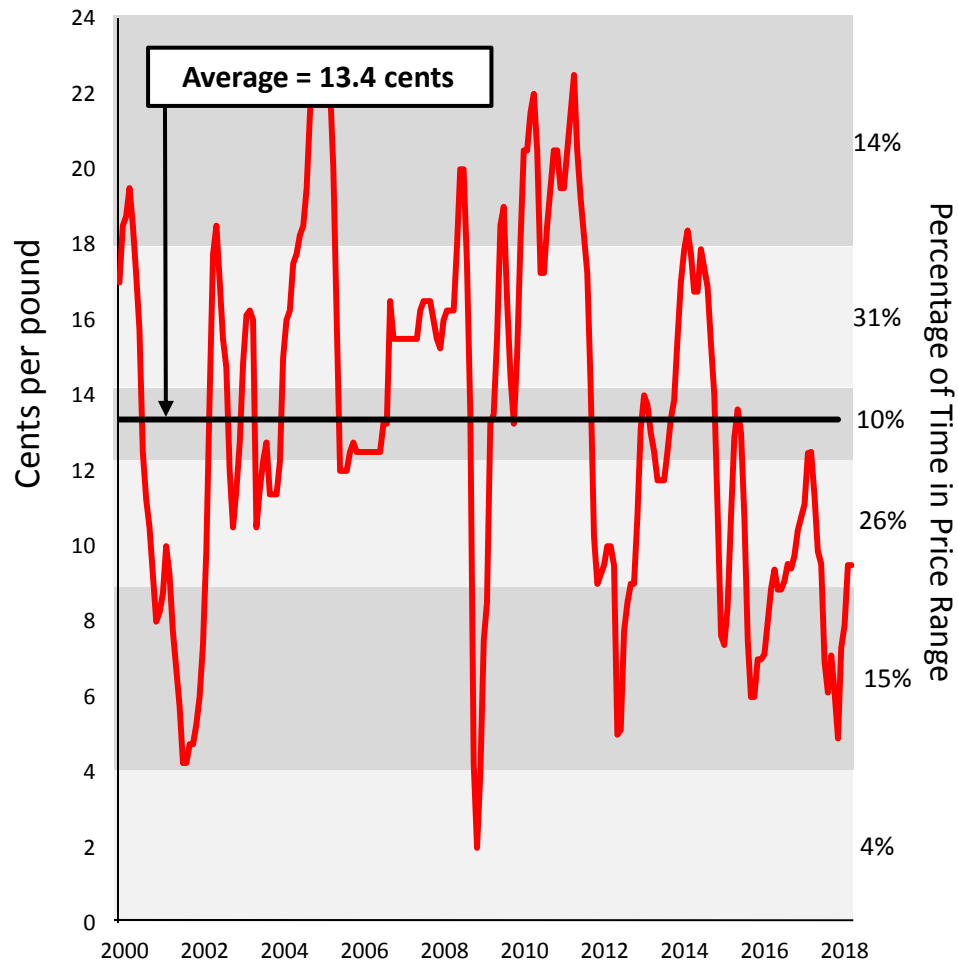

Source: IHS Markit

- Pricing has recovered from the 5 year lows experienced in December 2017
- USGC pricing in 1Q18 driven by new European demand along with an outage at a Brazilian vinyls producer
- Near-term volatility remains, as higher caustic soda prices continue to incentivize EDC production
- Our current full year 2018 Adjusted EBITDA forecast assumes lower EDC prices than 2017
- A 1 cent change in Olin's EDC sales price changes annual Adjusted EBITDA by \$20 million

Key Chlor Alkali Products & Vinyls EBITDA Sensitivity



Product	Price Change	Full Year EBITDA Impact
Chlorine	\$10/ton	\$10 million
Caustic Soda	\$10/ton	\$30 million
Ethylene Dichloride	\$.01/pound	\$20 million

Epoxy has Access to Attractive High Growth End Uses Around the Globe



Epoxy Resin Consumption

CAGR ('16-'21)

Select Epoxy End Use Applications

(Tons in thousands)

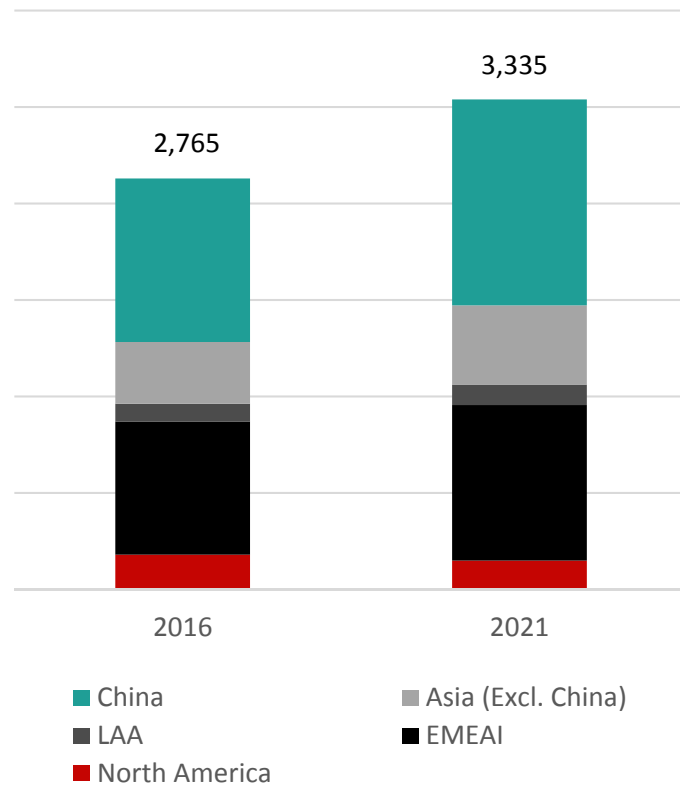

- 4.1%
- 2.7%
- 3.7%
- 4.7%
- 2.2%



Composites



Civil Engineering



Marine & Protective Coatings



Electrical Laminates

Source: IHS Markit Epoxy Resins Chemical Economics Handbook- Nov 2017

Liquid Epoxy Resin Pricing



- Improved supply / demand fundamentals for Liquid Epoxy Resin
- Higher liquid epoxy resin pricing in the U.S., Europe and Asia since 2016
- Global resin growth is between 3% and 5%

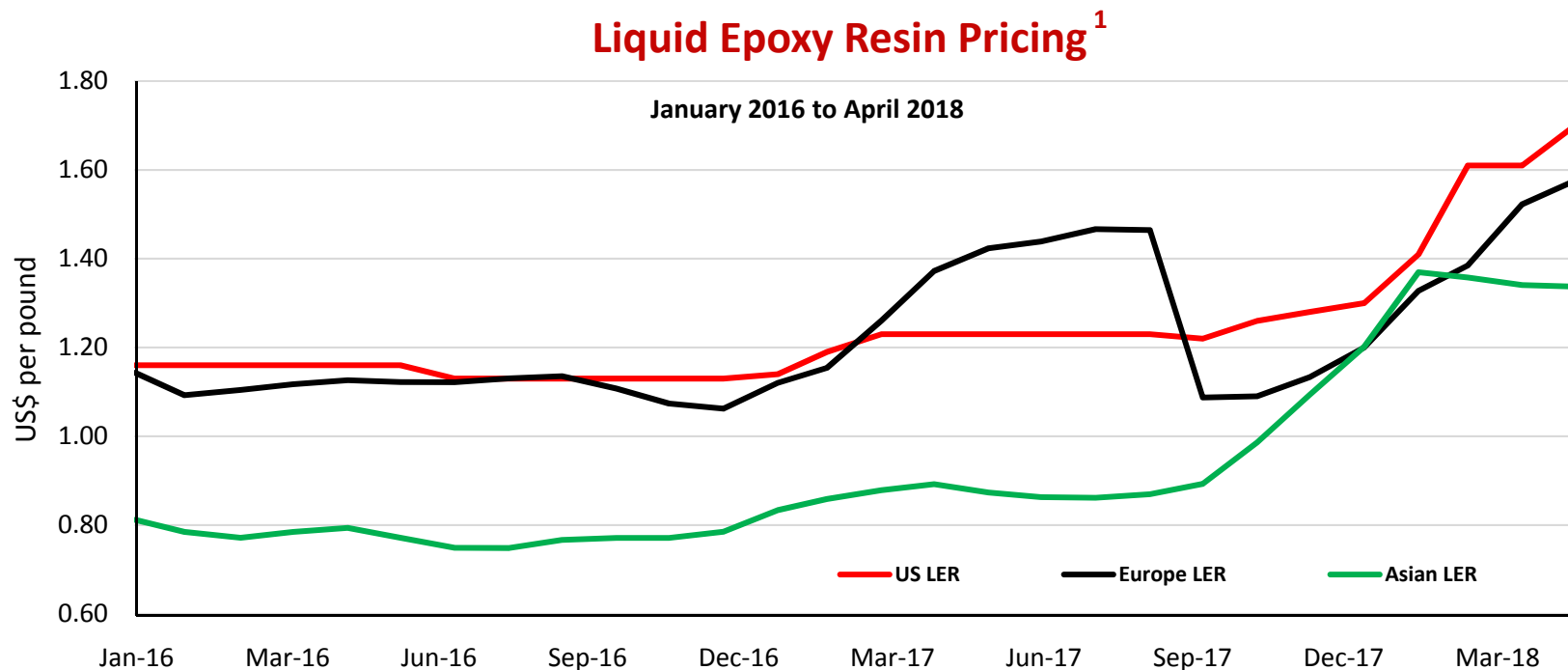

1. European liquid epoxy resin prices reflect a non-market adjustment made in the third quarter of 2017.

Source: ICIS

Epoxy Priorities for Success



	Upstream	Midstream	Downstream
1 Drive productivity to sustain cost advantage			
2 Focus on capturing the full value of our low-cost asset base ("Sell out")			N/A
3 Upgrade sales portfolio and product mix to improve margin ("Sell up")	N/A		

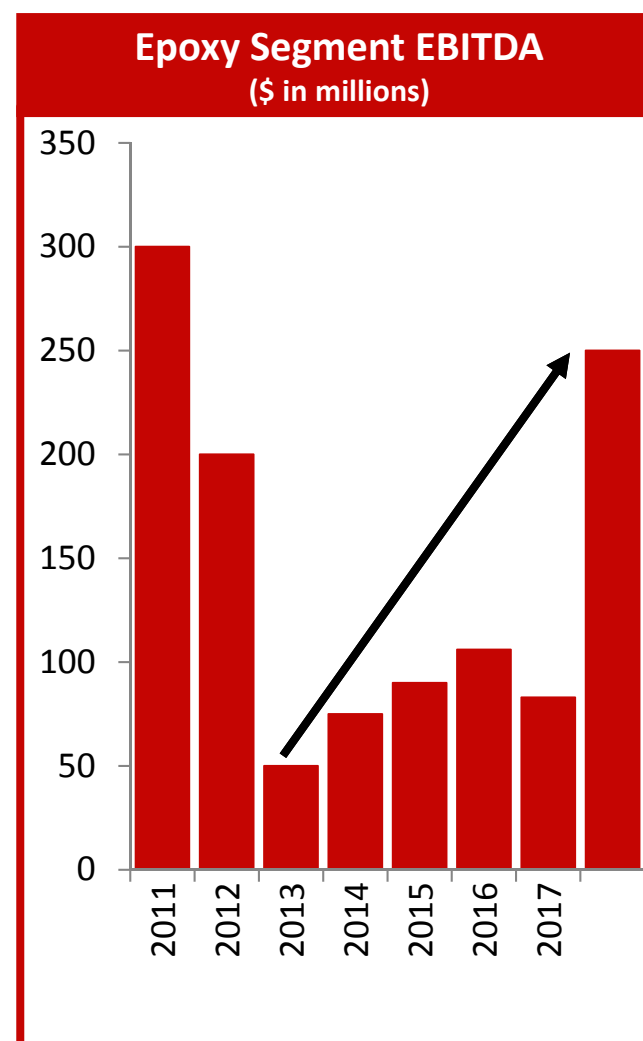

Winchester



Hunters & Recreational Shooters

Ammunition Products	Retail	Distributors	Mass Merchants	Law Enforcement	Military	Industrial
Rifle	✓	✓	✓	✓	✓	N/A
Handgun	✓	✓	✓	✓	✓	N/A
Rimfire	✓	✓	✓	✓	✓	✓
Shotshell	✓	✓	✓	✓	✓	✓
Components	✓	✓	✓	✓	✓	✓

Brands:



Winchester Adjusted EBITDA Margins

(\$ in millions)

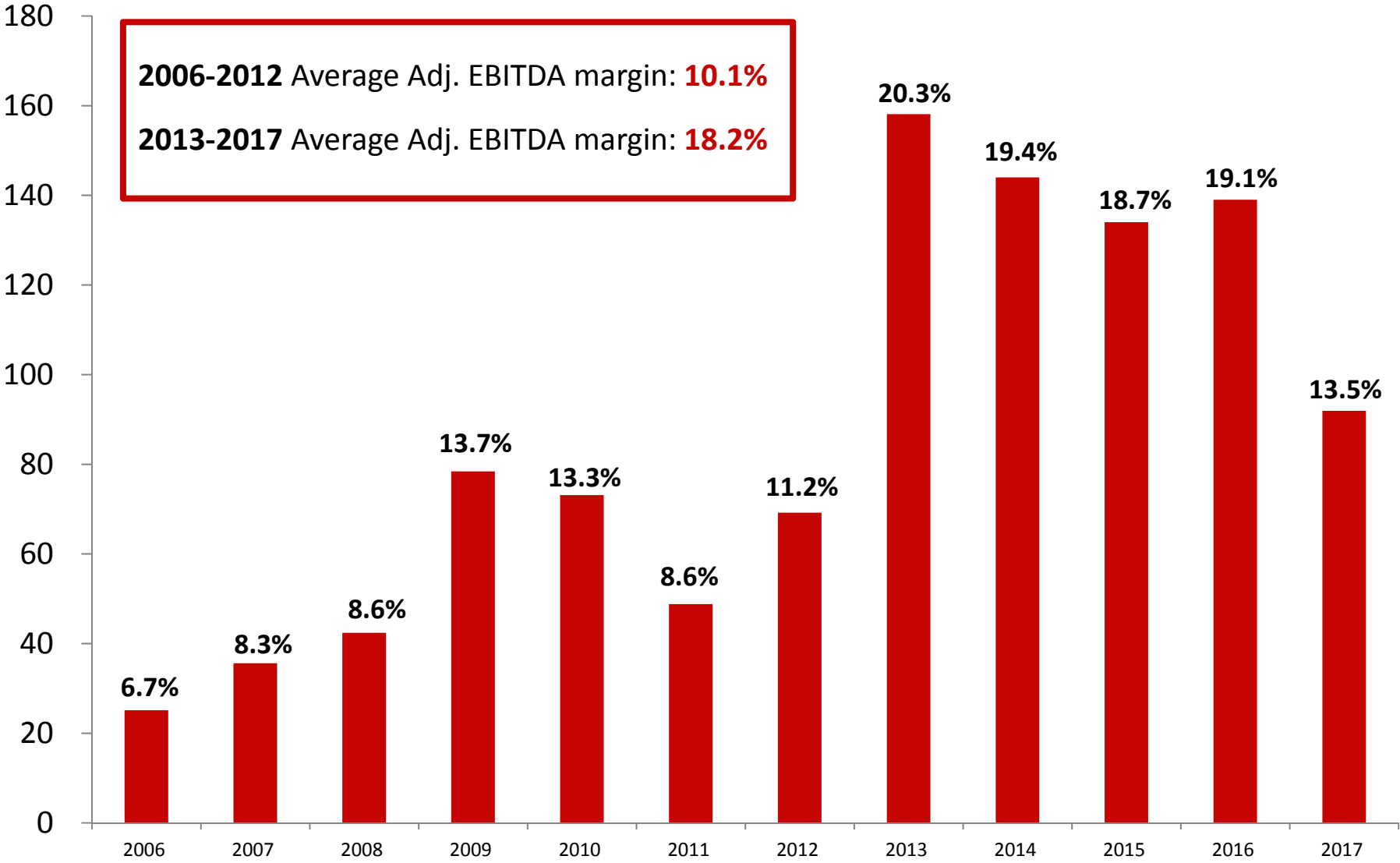

Full Year 2018 Adjusted EBITDA¹ Forecast

Current View: “More Upside Opportunities”



(\$ in millions)

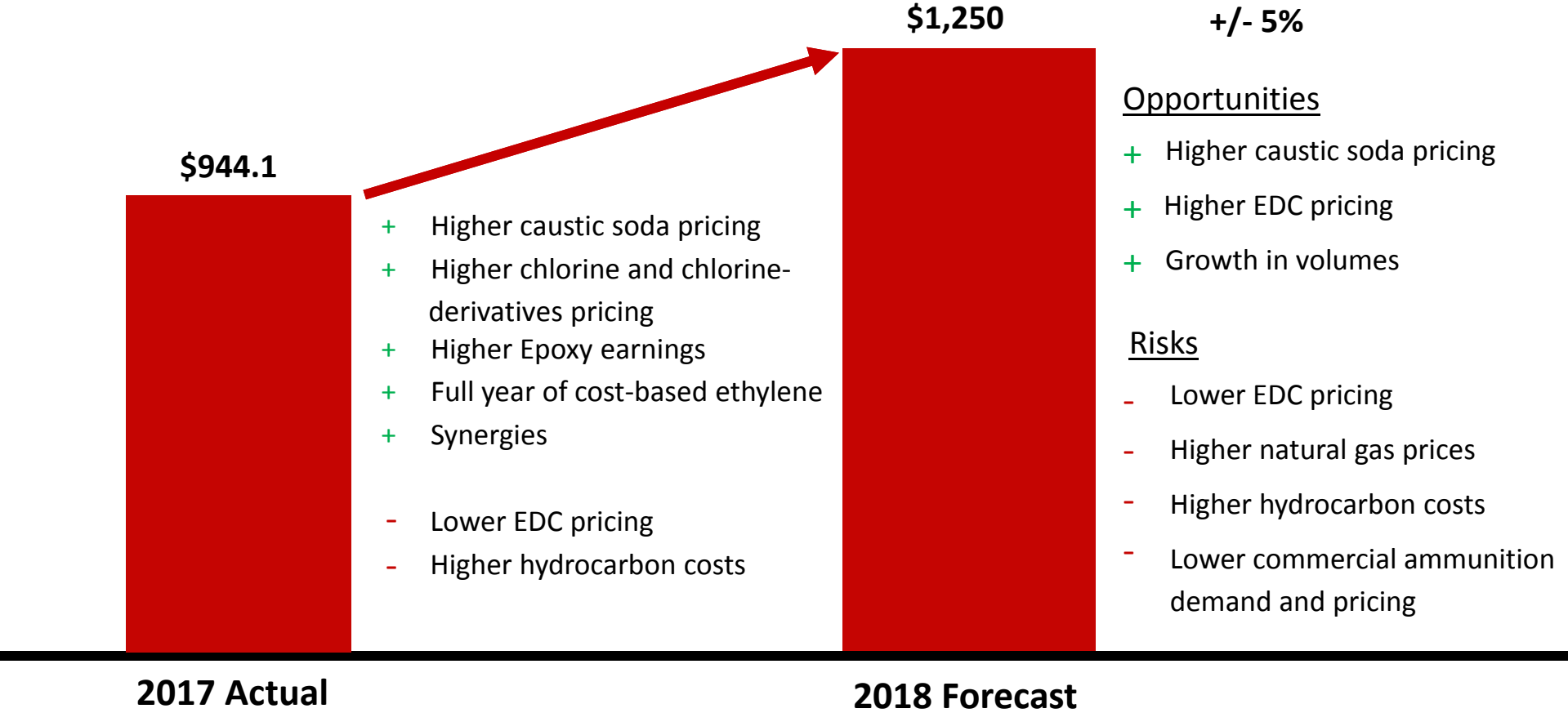

¹: Olin’s definition of “Adjusted EBITDA” (Earnings before interest, taxes, depreciation and amortization) is net income (loss) plus an add-back for depreciation and amortization, interest expense (income), income tax expense (benefit), other expense (income), restructuring charges, acquisition-related costs, and certain other non-recurring items.

2018 Cash Flow Forecast

Debt Reduction Remains Top Priority for Free Cash Flow



(\$ in millions)

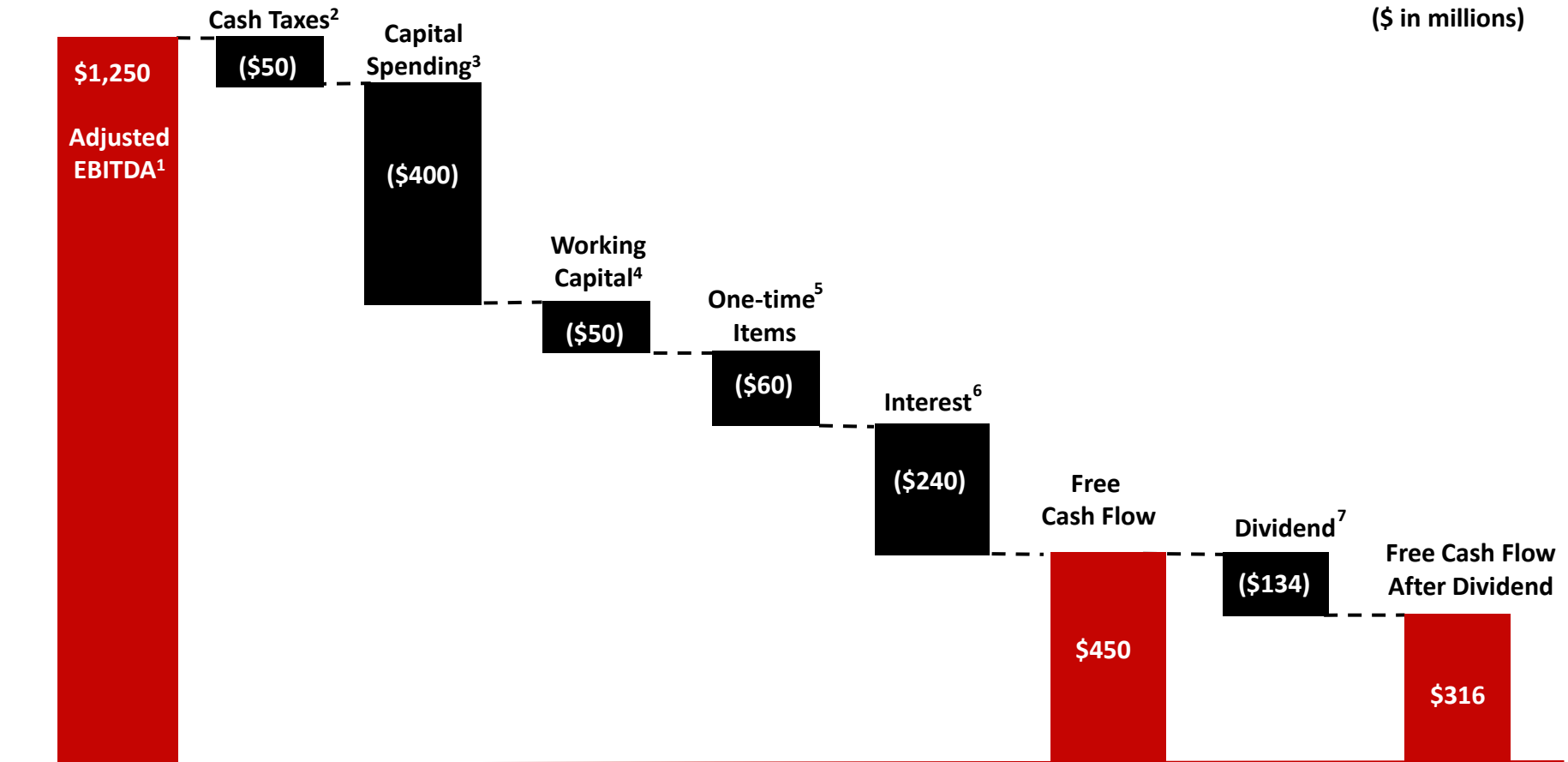

1: Mid-point of Olin's estimated Adjusted EBITDA forecast of \$1.25 billion plus or minus 5%. Includes pension income consistent with prior year's reporting

2: Estimated using the cash tax rate of 10% to 15%

3: Represents the mid-point of management's annual capital spending estimate range of \$375 million to \$425 million, which includes \$100 million associated with the information technology project

4: Estimated increase in working capital due to higher selling prices and hydrocarbon costs

5: One-time items include integration expenses, including the information technology project, cash restructuring charges, and an \$8.0 million insurance recovery

6: Calculated based on Olin's capital structure and assuming current interest rates

7: Calculated based on 167 million shares outstanding and an annual dividend of \$0.80 per share



Near-Term Adjusted EBITDA Potential

(\$ in millions)

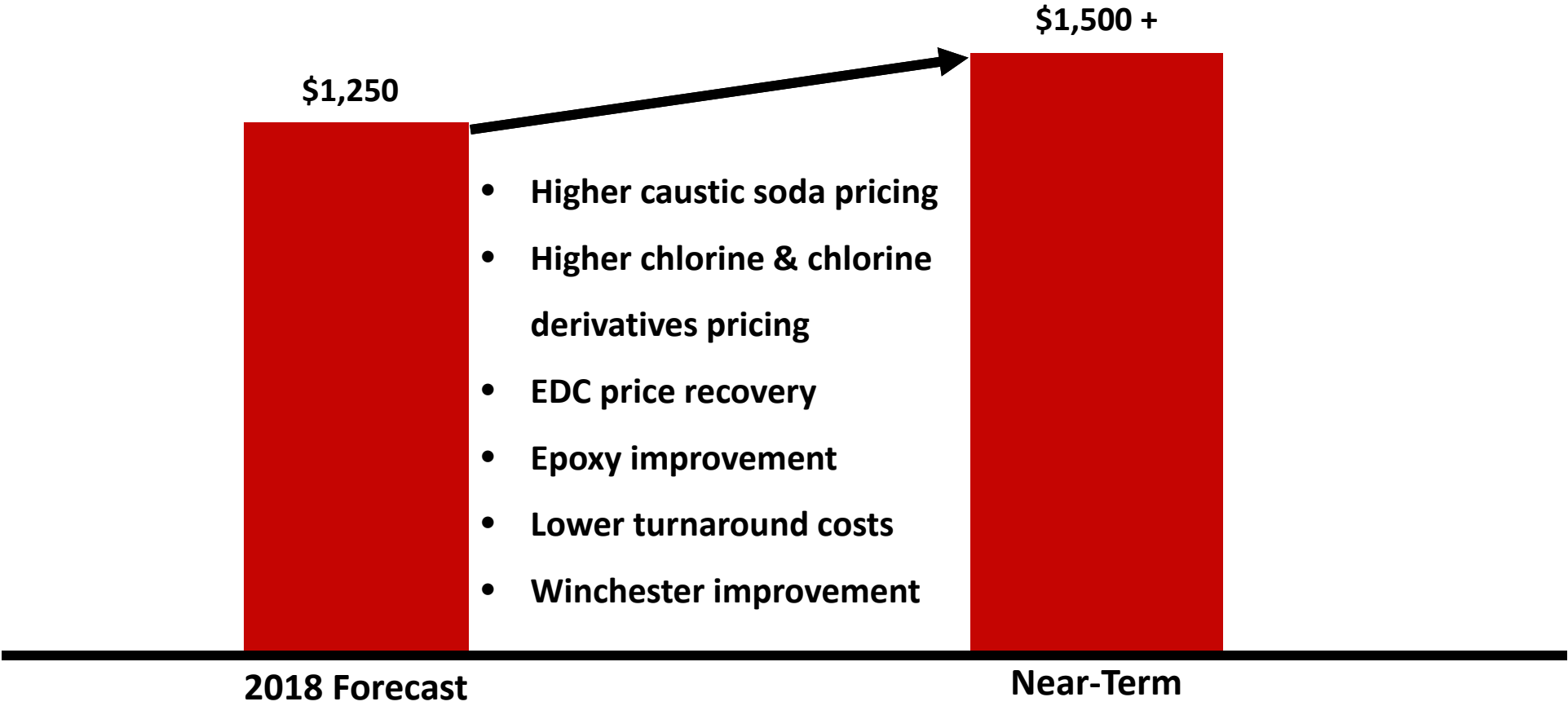

Appendix



The Chlorine Envelope

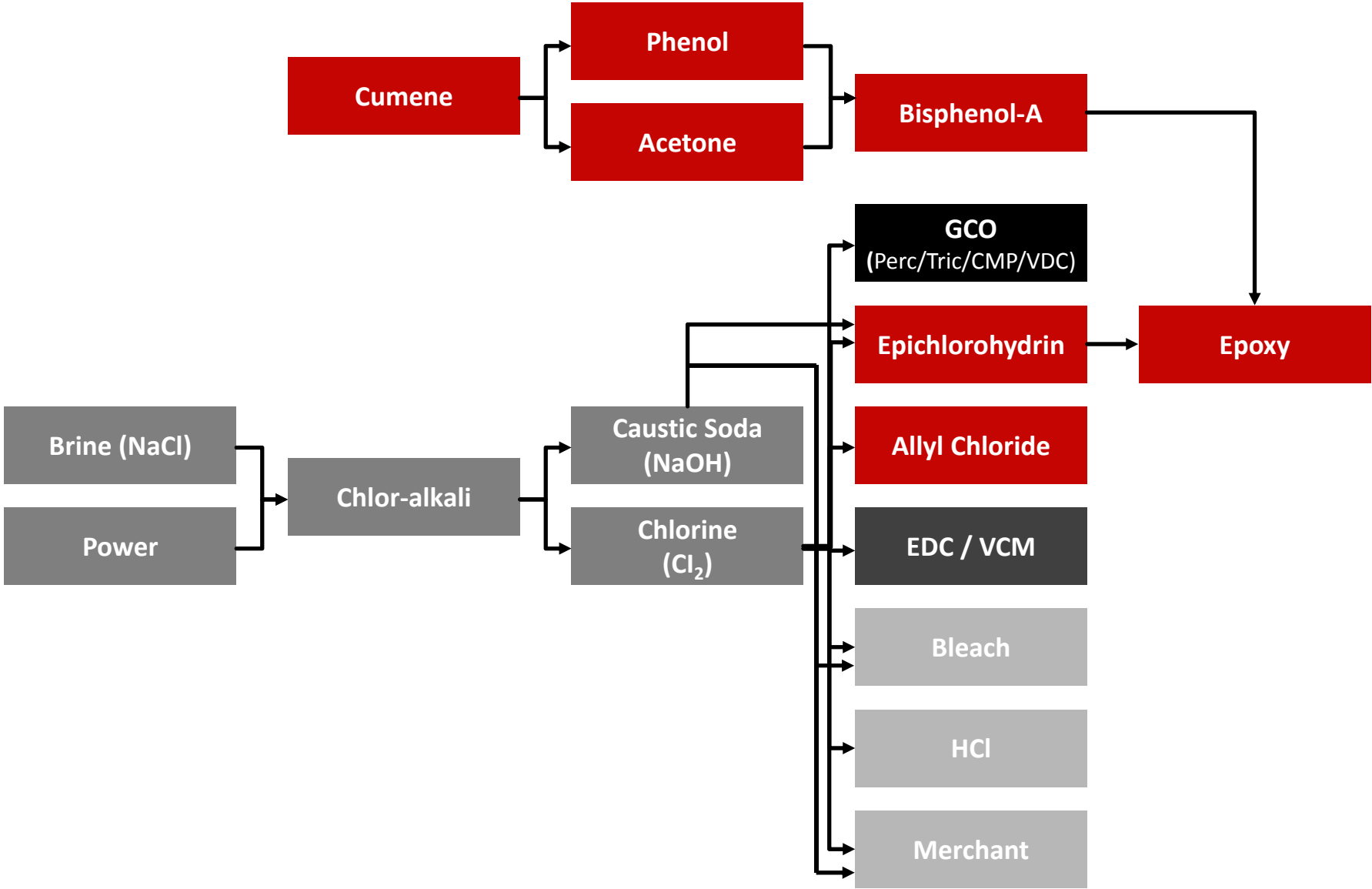

Chlor Alkali Products and Vinyls Segment Performance



(\$ in millions)

	1Q18	1Q17	Δ Q/Q
Sales	\$936.1	\$836.9	11.9%
Adjusted EBITDA	\$244.2	\$192.1	27.1%

- 1Q18 Performance vs. 1Q17
 - Higher caustic soda, chlorine and other chlorine-derivatives pricing, lower EDC pricing
 - Lower volumes
 - Lower ethylene costs
- 2Q18 Outlook vs. 2Q17
 - Expect improvement in caustic soda, chlorine and chlorine-derivatives pricing
 - Expect lower EDC pricing
 - Lower planned maintenance turnaround costs

Chlor Alkali Products and Vinyls

Pricing and Volume Comparisons



Volume Comparison

	1Q18 versus	
	1Q17	4Q17
Chlorine		
Caustic Soda		
EDC		
Bleach		
HCl		
Chlorinated Organics		

Pricing Comparison

	1Q18 versus	
	1Q17	4Q17
Chlorine		
Caustic Soda		
EDC		
Bleach		
HCl		
Chlorinated Organics		

Olin Caustic Soda Price Realization



Fundamental Principle

- A \$10 per ton change in Olin's caustic soda selling price changes annual Adjusted EBITDA by approximately \$30 million

Export Sales

- Typically range between 20% and 25% of caustic sales
- Sold on a combination of negotiated sales and export index price
- Realization of index price changes are typically 90% to 100%
- Changes in export index prices are typically realized on a 30 to 90 day lag

Domestic Sales

- A significant portion of domestic sales are linked to index prices
- Index price changes typically occur 30 to 60 days post our price nomination
- Realization of index price changes are typically 50% to 100%
- Overall price realization lags index price changes by 30 to 90 days

Advantaged Ethylene Arrangement



- A series of three supply agreements with Dow
- Pipeline supply without operating or start-up risk
- Producer economics for 20 years for each tranche

Tranche	Effective Date	Annual Volume (short-tons)	Cost (millions)
#1	Acquired at closing	Up to 180,000	\$433 ¹
#2	Acquired late September 2017	Up to 160,000	\$209
#3	Available ~ 4Q 2020	Up to 300,000	\$440-\$465

1. Includes option payments for Tranches #2 and #3; all options to obtain future cost-based ethylene have been exercised

Epoxy Segment Performance



(\$ in millions)

	1Q18	1Q17	Δ Q/Q
Sales	\$603.3	\$567.6	6.3%
Adjusted EBITDA	\$4.6	\$21.2	-78.3%

- 1Q18 Performance vs. 1Q17
 - Higher product pricing, partially offset by higher raw material costs
 - Higher planned maintenance turnaround costs of approximately \$43 million
- 2Q18 Outlook vs. 2Q17
 - Expect higher product pricing
 - Expect higher raw materials costs associated with benzene and propylene

Raw Material Costs - Benzene & Propylene Pricing



Benzene Pricing

January 2016 to April 2018

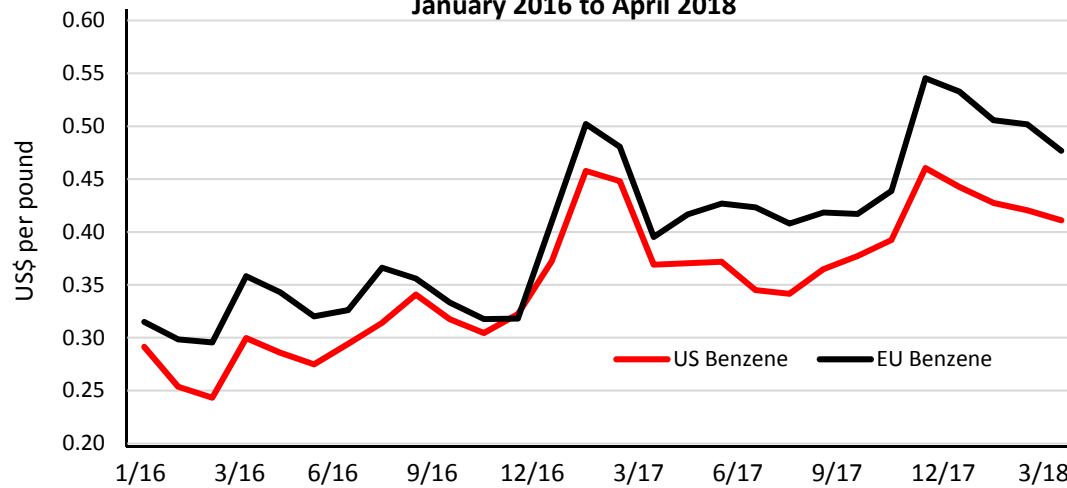

- 1Q18 U.S. benzene prices higher than 1Q17 and 4Q17
- European benzene 1Q18 prices lower than 1Q17, but higher than 4Q17
- U.S. and European propylene prices are higher in 1Q18 versus 1Q17 and 4Q17

Propylene Pricing

January 2016 to April 2018

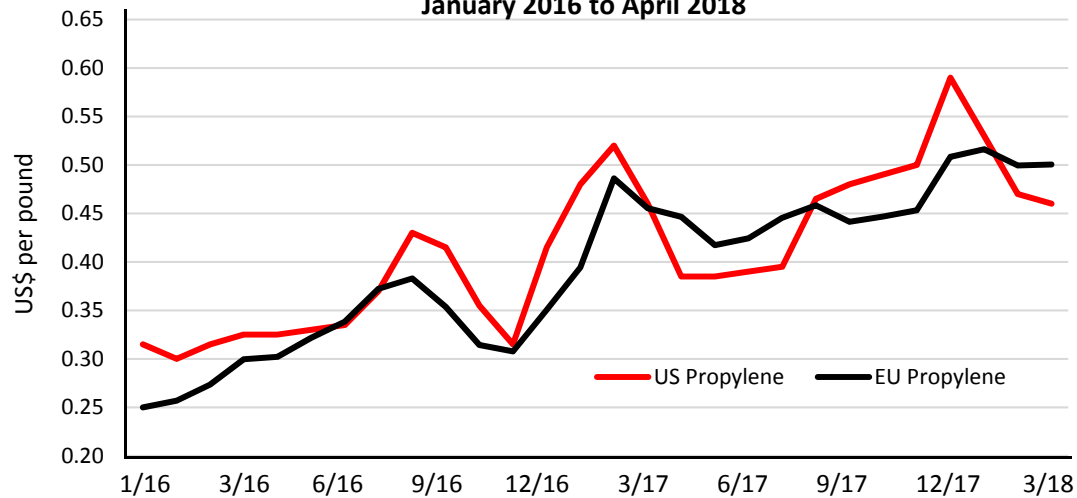

Source: ICIS

Maintenance Turnaround Expenses

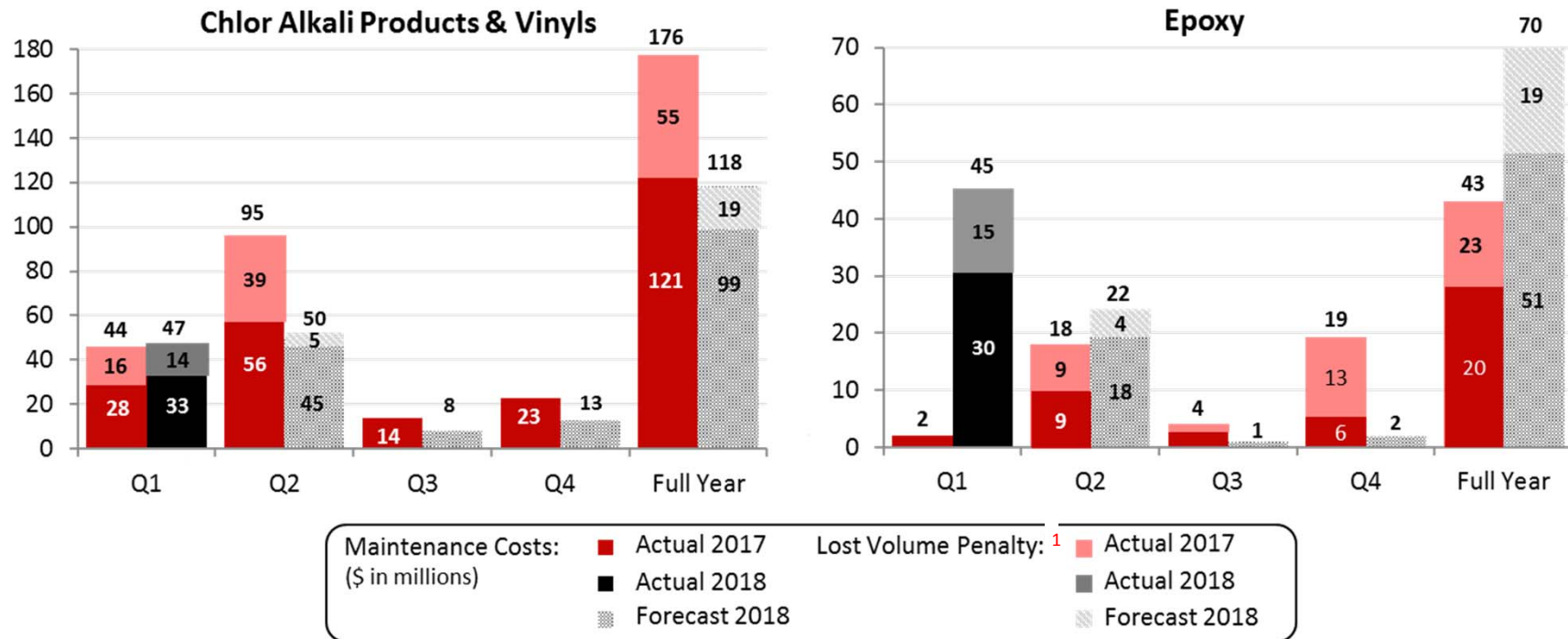

- Full year 2018 turnaround costs expected to be approximately \$30 million lower than 2017
- CAPV Freeport, TX, Plaquemine, LA and McIntosh, AL planned turnarounds completed
- Epoxy Freeport, TX two-month planned turnaround completed in April

1. Lost volume penalty includes unabsorbed fixed manufacturing costs and reduced pretax profit from lost sales associated with the turnarounds and outages

Significant Realizable Synergies



(\$ in millions)

	Actual 2016	Actual 2017	Synergies Breakdown	Forecast 2018	Total Synergies
Logistics & Procurement					
Operational Efficiencies	\$75	\$100	Projected Annual Impact	\$75-\$100	\$250-\$275
Asset Optimization					
Accessing New Segments & Customers	\$6	\$30	Projected Annual Impact	\$50-\$65	\$85-\$100
Capital Investment	\$205	\$30	Projected CAPEX & Investments	\$0	\$235
	\$70	\$35	Projected Cash Integration & Restructuring	\$20	\$125

Winchester Segment Performance



(\$ in millions)

	1Q18	1Q17	Δ Q/Q
Sales	\$170.9	\$162.6	5.1%
Adjusted EBITDA	\$17.1	\$30.0	-43.0%

- 1Q18 Performance vs. 1Q17
 - Lower commercial sales partially offset by higher military volumes
 - Less favorable product mix and lower selling prices
 - Higher commodity and other material costs
- 2Q18 Outlook vs. 2Q17
 - Expect higher sales to military customers
 - Expect lower commercial volumes and less favorable product mix
 - Expect higher commodity and other material costs

2018 Forecast Assumptions



(\$ in millions)

Line Item	Forecast	Key Elements
Capital Spending	\$375 to \$425	Maintenance level of capital spending of \$225M to \$275M annually, information technology project spending of \$100M and other projects
Depreciation & Amortization	\$570 to \$580	Forecast is an increase from 2017 levels of \$559M
Non-operating Pension Income	\$20 to \$25	Lower than 2017 income levels by approximately \$10M to \$15M
Environmental Expense	\$15 to \$20	Represents a more historic level of expense
Other Corporate & Unallocated Costs	\$110 to \$120	Forecast is an increase from 2017 levels due to stock-based compensation and legal and litigation costs
Restructuring & Acquisition Costs	\$70	Acquisition related integration, including information technology project and restructuring costs
Book Effective Tax Rate	25%	Reflects 2017 tax law changes and favorable book/tax deductions, partially offset by state and foreign income taxes
Cash Tax Rate	10% to 15%	Reflects 2017 tax law changes and 2017 tax credit carryforwards benefits; primarily paying foreign income taxes in 2017

Non-GAAP Financial Measures – Adjusted EBITDA ^(a)



Olin's definition of Adjusted EBITDA (Earnings before interest, taxes, depreciation, and amortization) is net income (loss) plus an add-back for depreciation and amortization, interest expense (income), income tax expense (benefit), other expense (income), restructuring charges, acquisition-related costs and certain other non-recurring items. Adjusted EBITDA is a non-GAAP financial measure. Management believes that this measure is meaningful to investors as a supplemental financial measure to assess the financial performance without regard to financing methods, capital structures, taxes or historical cost basis. The use of non-GAAP financial measures is not intended to replace any measures of performance determined in accordance with GAAP and Adjusted EBITDA presented may not be comparable to similarly titled measures of other companies. Reconciliation of forward-looking non-GAAP financial measures to the most directly comparable GAAP financial measures are omitted from this release because Olin is unable to provide such reconciliations without the use of unreasonable efforts. This inability results from the inherent difficulty in forecasting generally and quantifying certain projected amounts that are necessary for such reconciliations. In particular, sufficient information is not available to calculate certain adjustments required for such reconciliations, including interest expense (income), income tax expense (benefit), other expense (income), restructuring charges and acquisition-related costs. Because of our inability to calculate such adjustments, forward-looking net income guidance is also omitted from this release. We expect these adjustments to have a potentially significant impact on our future GAAP financial results.

(In millions)	Three Months Ended March 31,		Year Ended December 31,
	2018	2017	2017
Reconciliation of Net Income to Adjusted EBITDA:			
Net Income	\$ 20.9	\$ 13.4	\$ 549.5
Add Back:			
Interest Expense	63.7	52.4	217.4
Interest Income	(0.4)	(0.2)	(1.8)
Income Tax Provision (Benefit) (b)	6.6	4.5	(432.3)
Depreciation and Amortization	146.7	135.1	558.9
EBITDA	237.5	205.2	891.7
Add Back:			
Restructuring Charges (c)	4.0	8.2	37.6
Acquisition-related Costs (d)	0.3	7.0	12.8
Information Technology Integration Project (e)	6.5	-	5.3
Certain Non-recurring Items (f)	(8.0)	-	(3.3)
Adjusted EBITDA	\$ 240.3	\$ 220.4	\$ 944.1

(a) Unaudited.

(b) Income tax provision (benefit) for the year ended December 31, 2017 reflects the tax benefit of \$437.9 million from the Tax Cuts & Jobs Act.

(c) Restructuring charges for both the three months ended March 31, 2018 and 2017 and the year ended December 31, 2017 were primarily associated with the closure of 433,000 tons of chlor alkali capacity across three separate Olin locations.

(d) Acquisition-related costs for both the three months ended March 31, 2018 and 2017 and the year ended December 31, 2017 were associated with our integration of the Acquired Business.

(e) Information technology integration project for the three months ended March 31, 2018 and year ended December 31, 2017 included costs associated with the implementation of new enterprise resource planning, manufacturing, and engineering systems, and related infrastructure costs of \$6.5 million and \$5.3 million, respectively.

(f) Certain non-recurring items for the three months ended March 31, 2018 included an \$8.0 million insurance recovery associated with a second quarter 2017 business interruption at our Freeport, Texas vinyl chloride monomer facility. Certain non-recurring items for the year ended December 31, 2017 included a gain of \$3.3 million on the sale of a former manufacturing facility.

Non-GAAP Financial Measures by Segment



Three Months Ended March 31, 2018			
(In millions)			
	Income (loss) before Taxes	Depreciation and Amortization	Adjusted EBITDA
Chlor Alkali Products and Vinyls	\$ 130.5	\$ 113.7	\$ 244.2
Epoxy	(22.1)	26.7	4.6
Winchester	12.0	5.1	17.1
Three Months Ended March 31, 2017			
	Income (loss) before Taxes	Depreciation and Amortization	Adjusted EBITDA
Chlor Alkali Products and Vinyls	\$ 87.5	\$ 104.6	\$ 192.1
Epoxy	(1.2)	22.4	21.2
Winchester	25.1	4.9	30.0
Year Ended December 31, 2017			
	Income (loss) before Taxes	Depreciation and Amortization	Adjusted EBITDA
Chlor Alkali Products and Vinyls	\$ 405.8	\$ 432.2	\$ 838.0
Epoxy	(11.8)	94.3	82.5
Winchester	72.4	19.5	91.9